

# [MAGUIRE METALS]

PROTECTING YOUR FUTURE



**(905)373-2041**  
**INFO@MAGUIREMETALS.CA**

**PROUDLY SERVING  
HOMEOWNERS &  
CONTRACTORS  
ALL OVER ONTARIO**

# THE LANDON PANEL

(EXPOSED FASTENER)

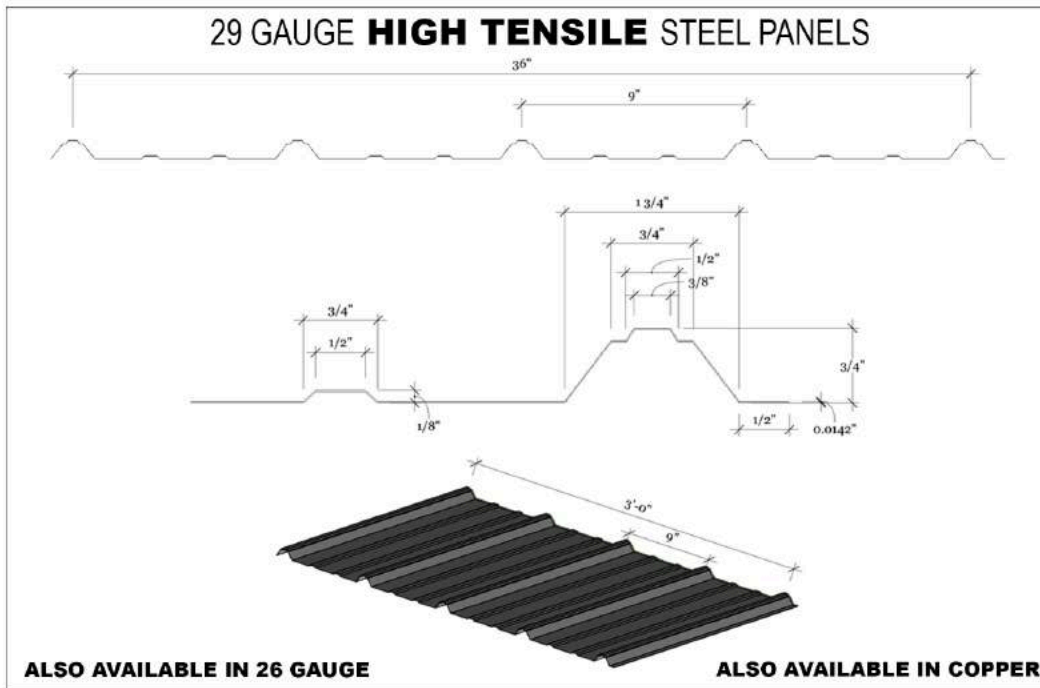

**TEXTURED  
BLACK**



**TEXTURED  
DARK BROWN**

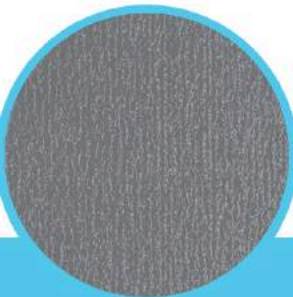

**TEXTURED  
CHARCOAL**

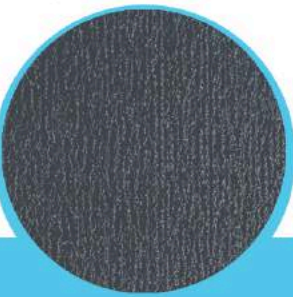

**TEXTURED  
DARK GRAPHITE**

\*ADDITIONAL COLOURS AVAILABLE UPON REQUEST (905)373-2041\*



**GLOSS  
WHITE**



**GLOSS  
BRIGHT RED**



**PURE & FAUX  
COPPER**



**GLOSS  
SLATE BLUE**



**MELCHERS  
GREEN**



**COFFEE  
BROWN**



**GLOSS DARK  
BROWN**



**GLOSS  
CHARCOAL**



**GLOSS DARK  
GRAPHITE**



**GLOSS  
BLACK**



**GALVALUME**

# STANDARD & CUSTOM TRIMS <sup>2</sup>

AVAILABLE IN ALL COLOURS INCLUDING COPPER

GABLES

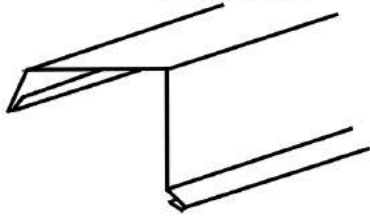

VALLEYS



DRIP EDGE

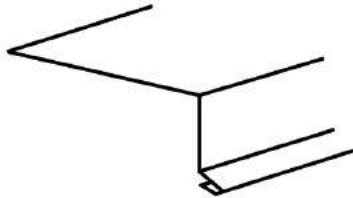

RIDGE & HIP CAPS

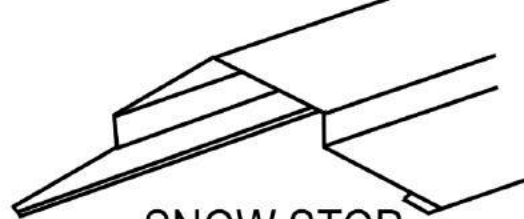

WALL FLASHINGS

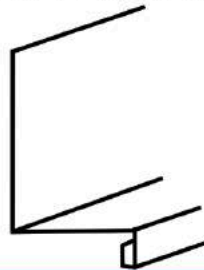

SNOW STOP

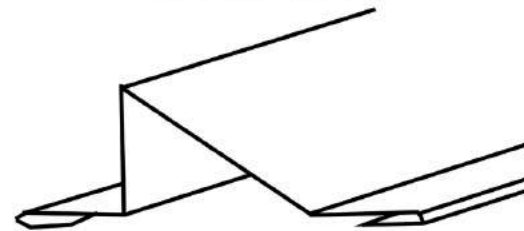

## ACCESSORIES READILY AVAILABLE:



CT4



SCREWS



EMSEAL



RIDGE FOAM



MAXI VENT



PIPE BOOT



ZIPPER BOOT



CAULKING

CUSTOM TRIMS AND ACCESSORIES AVAILABLE UPON REQUEST - (905)373-2041



FLAT PAN



STIFFENING RIBS

# SNAPLOCK STANDING SEAM



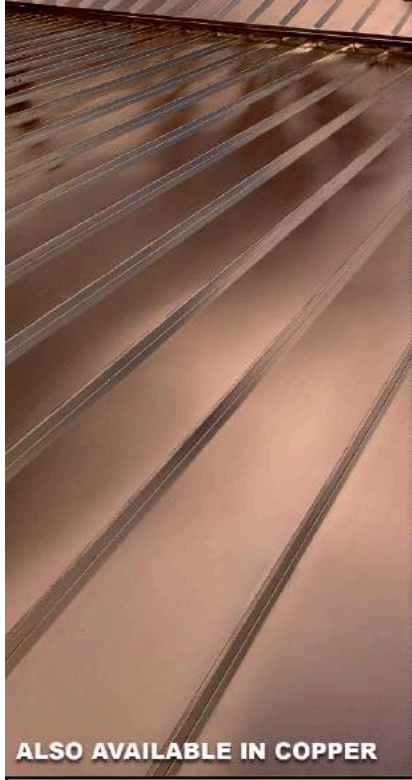

ALSO AVAILABLE IN COPPER

### FEATURES:

- NO SEAMING REQUIRED
- NO EXPOSED FASTENERS
- VARIOUS THICKNESSES
- FULL RANGE OF COLOURS
- WILL LAST A LIFETIME

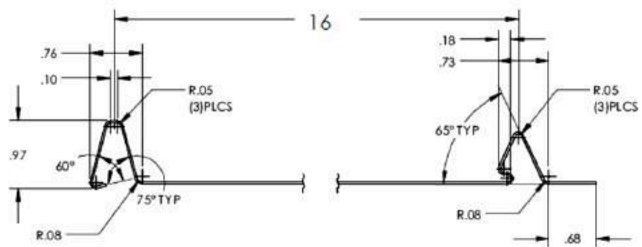

AVAILABLE IN 26 OR 24 GAUGE STEEL



**TEXTURED  
BLACK**



**TEXTURED  
DARK BROWN**

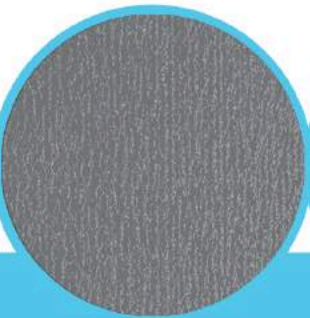

**TEXTURED  
CHARCOAL**

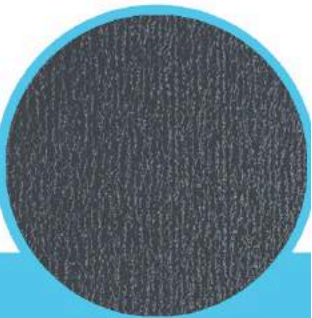

**TEXTURED  
DARK  
GRAPHITE**

\*OTHER COLOURS AVAILABLE UPON REQUEST (905)373-2041\*



# VERTICAL BOARD & BATTEN STEEL SIDING



## WHY CHOOSE STEEL AND NOT VINYL?

In Canada's extreme weather, vinyl, and aluminum siding face problems. They crack when it's cold and warp with the heat. Fixing them helps, but they never look the same. Our Vertical Board-and-Batten Steel Siding is different. It's tough, keeps its good looks for years, and doesn't need much care. This steel siding is a better choice, offering peace of mind and long-term value. It's a smart pick for anyone in our harsh climate, keeping your home looking good and standing strong.

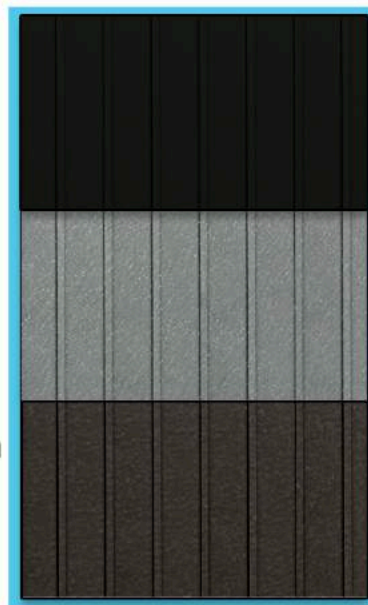

**CALL US FOR MORE INFORMATION (905)373-2041**

# MAGNUM STEEL PANELS

## 25 GAUGE STEEL

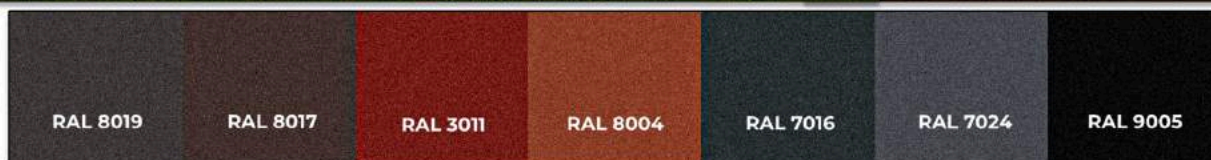
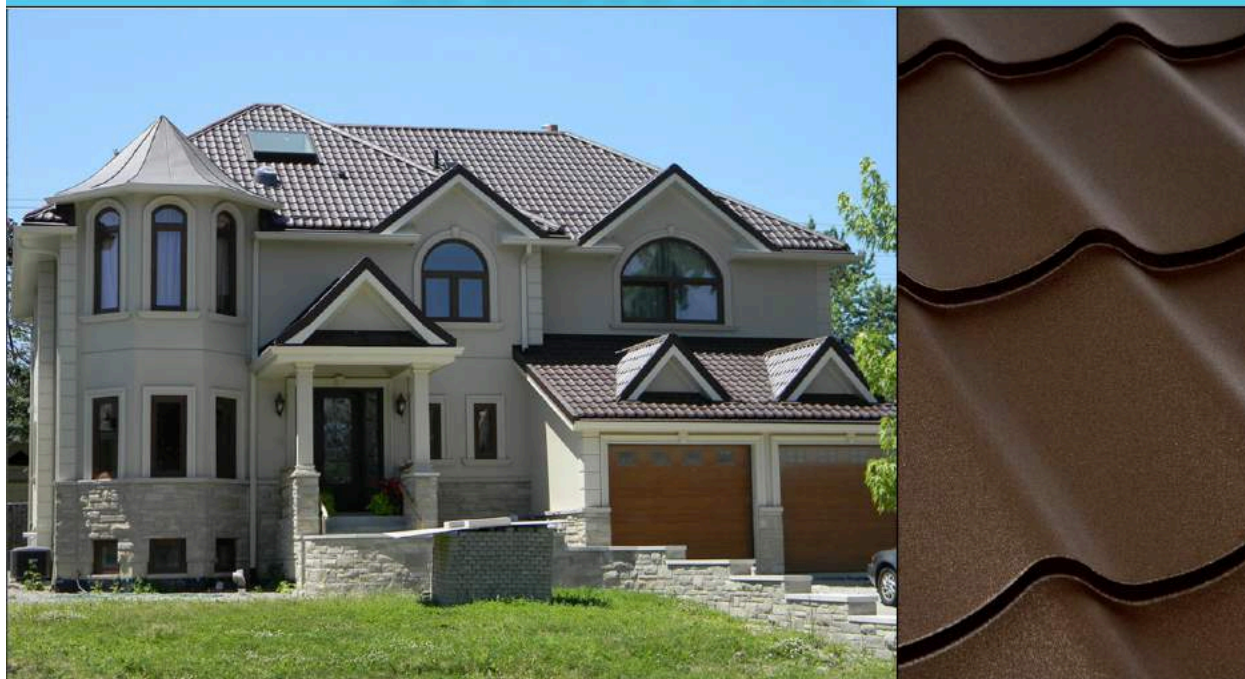

- MATTE FINISH
- 50 YEAR WARRANTY
- SAVE ON INSURANCE
- MAINTENANCE FREE
- ENERGY EFFICIENT
- ECO FRIENDLY
- FIRE, HAIL & WIND RESISTANT

### HOW TO CHOOSE THE BEST METAL ROOF COLOUR ?

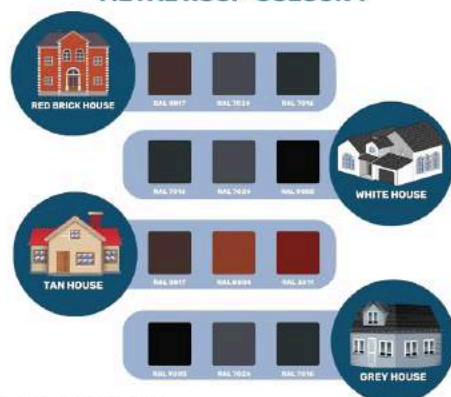

**CALL US FOR MORE INFORMATION! (905)373-2041**

**40**  
YEAR  
PAINT FINISH  
WARRANTY

**[MAGUIRE]**  
**METALS**  
PROTECTING YOUR FUTURE



SCAN ME!

**CONTACT US TODAY!**  
**(905)373-2041**  
**INFO@MAGUIREMETALS.CA**



**PROUD PARTNER OF**

**401SIDING**  
SIDING • SOFFIT • FASCIA



**MOFFATT BROS. ROOFING LTD.**  
ROOFING WITH INTELLIGENCE & INTEGRITY

371 LANDON RD,  
CASTLETON, ON